

Assimilation of L-band brightness temperatures in the ECMWF Land Data Assimilation System

J. Muñoz Sabater

P. de Rosnay, C. Albergel, G. Balsamo, L. Isaksen, S. Boussetta and M. Drusch

European Centre for Medium-Range Weather Forecasts (ECMWF), Reading, UK

&

European Space Agency, Noordwijk, The Netherlands

Objectives at ECMWF (I): Monitoring

- **Routinely production of statistics with SMOS T_B , model equivalents and background departures, in NRT**
 - Global scale
 - Land and oceans separately,
 - Several incidence angles [10, 20, 30, 40, 50, 60],
 - Two polarisations states [XX, YY],
 - Independently per continents and hemispheres,
- **Statistical products,**
 - Time-averaged geographical mean-fields (last 6 weeks of data),
 - Hovmöller zonal mean fields (last 3 months),
 - Time series of area averages (last 3 months),
 - Angular distribution of bias: background departures as function of incidence angle (last 5 weeks).
- **Support to CAL/VAL sites** → time series produced for 17 sites

564 images are produced and updated daily → important contribution to the SMOS quality control

Time-averaged geographical mean fields



Hovmoeller zonal mean fields

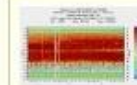

Time series of area averages

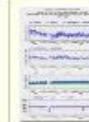

Scatter plots

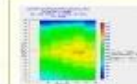

Time series of area averages (over land)

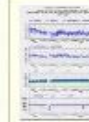

Time series of area averages (over Sea)



Time series of targeted sites statistics (over Land)



Objectives at ECMWF (II): Assimilation

- **Assimilation** of SMOS T_B over continental surfaces & investigate the meteorological impact of SMOS data assimilation

Simplified Extended Kalman Filter:

For each grid point, analysed state vector \mathbf{x}_a :

$$\mathbf{x}_a = \mathbf{x}_b + \mathbf{K} (\mathbf{y} - \mathcal{H}[\mathbf{x}_b])$$

\mathbf{x}_b : background state vector,

\mathbf{y} : observation vector

\mathcal{H} : non linear observation operator

\mathbf{K} : Kalman gain matrix: $\mathbf{K} = [\mathbf{B}^{-1} + \mathbf{H}^T \mathbf{R}^{-1} \mathbf{H}]^{-1} \mathbf{H}^T \mathbf{R}^{-1}$

Observations:

- Screen level variables: T^{2m} , RH^{2m}
- Remote sensing data:
 - ASCAT soil water index (METOP-A, METOP-B),
 - SMOS Brightness temperatures

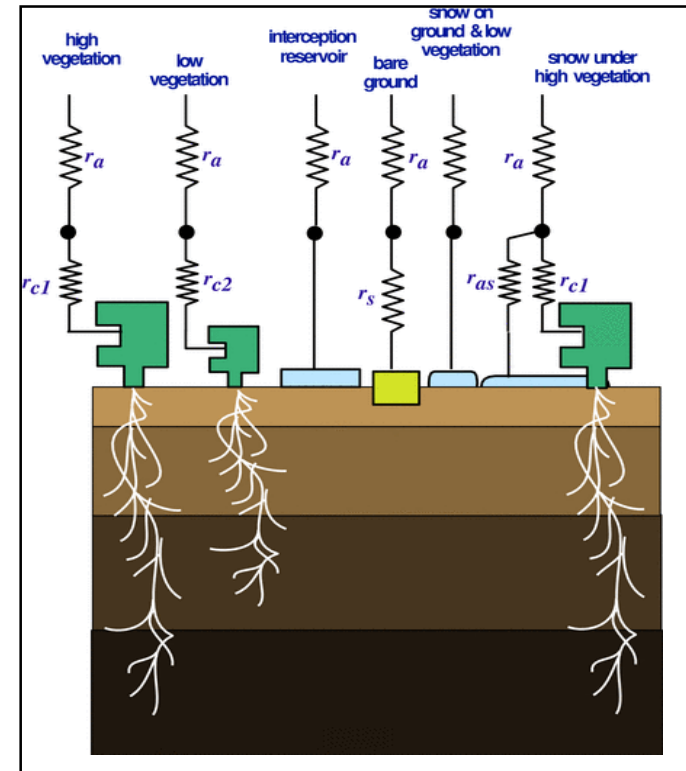

LSM : HTESSEL

0-7cm, 7-28cm, 28-100cm,
100-289cm

Summer validation (JJA) ; top layer (0-7 cm)

- **SLV:** assimilation of T^{2m} , RH^{2m}
- **SMOS:** assimilation of only SMOS T_B CDF corrected
- **SMOS+SLV:** assimilation of T^{2m} , RH^{2m} and SMOS T_B CDF
- Validation undertaken over significant stations (p-value<0.05) in 8 countries



→ The worst among the 3 expt.

→ Neither the best nor the worse

→ The best among the 3 expt.

SLV

Network	Bias	RMSD	R
SMOSMANIA	-0.017	0.067	0.77
TWENTE	0.024	0.097	0.77
SCAN	-0.088	0.137	0.55
USCRN	-0.079	0.115	0.67
MAQU	0.027	0.067	0.75
SWATMEX	-0.080	0.095	0.80
VAS	-0.082	0.105	0.48
OZNET	-0.104	0.122	0.69
REMEDHUS	-0.065	0.093	0.57
UMBRIA	-0.153	0.159	0.65
HOBE	-0.052	0.076	0.70

SMOS

Network	Bias	RMSD	R
SMOSMANIA	-0.043	0.085	0.71
TWENTE	-0.013	0.099	0.71
SCAN	-0.076	0.132	0.55
USCRN	-0.072	0.116	0.64
MAQU	0.064	0.089	0.79
SWATMEX	-0.126	0.138	0.74
VAS	-0.072	0.079	0.53
OZNET	-0.098	0.118	0.72
REMEDHUS	-0.058	0.080	0.73
UMBRIA	-0.207	0.210	0.47
HOBE	-0.031	0.066	0.57

SMOS + SLV

Network	Bias	RMSD	R	N
SMOSMANIA	-0.015	0.064	0.78	9
TWENTE	0.005	0.095	0.76	18
SCAN	-0.082	0.135	0.57	98
USCRN	-0.074	0.115	0.69	61
MAQU	0.026	0.067	0.74	16
SWATMEX	-0.082	0.098	0.79	8
VAS	-0.085	0.099	0.59	1
OZNET	-0.104	0.122	0.71	30
REMEDHUS	-0.068	0.092	0.61	17
UMBRIA	-0.153	0.159	0.67	2
HOBE	-0.033	0.067	0.69	30

Summer validation (JJA) ; root-zone (0-100 cm)

- **SLV:** assimilation of T^{2m} , RH^{2m}
- **SMOS:** assimilation of only SMOS T_B CDF corrected
- **SMOS+SLV:** assimilation of T^{2m} , RH^{2m} and SMOS T_B CDF corrected

- Validation undertaken over 77 (SCAN) and 50 (USCRN) stations (p -value <0.05)
- Observations are averaged over 5, 10, 20, 50 cm (and 100 cm also for USCRN)
- Model SM is averaged over the three layers (7, 28, 100 cm)

SLV

Network	Bias (m^3m^{-3})	RMSD (m^3m^{-3})	R	N
SCAN	-0.041	0.113	0.72	77
USCRN	-0.072	0.111	0.66	50

SMOS

Network	Bias (m^3m^{-3})	RMSD (m^3m^{-3})	R	N
SCAN	-0.027	0.119	0.72	77
USCRN	-0.064	0.106	0.70	50

SMOS + SLV

Network	Bias (m^3m^{-3})	RMSD (m^3m^{-3})	R	N
SCAN	-0.040	0.115	0.73	77
USCRN	-0.066	0.109	0.69	50



→ The worst among the 3 expt.

→ Neither the best nor the worse

→ The best among the 3 expt.

Soil moisture forecast impact

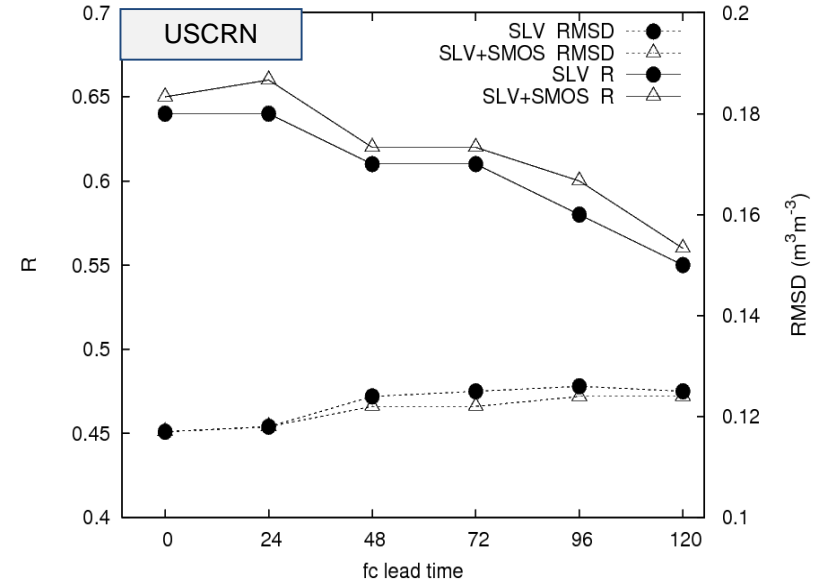
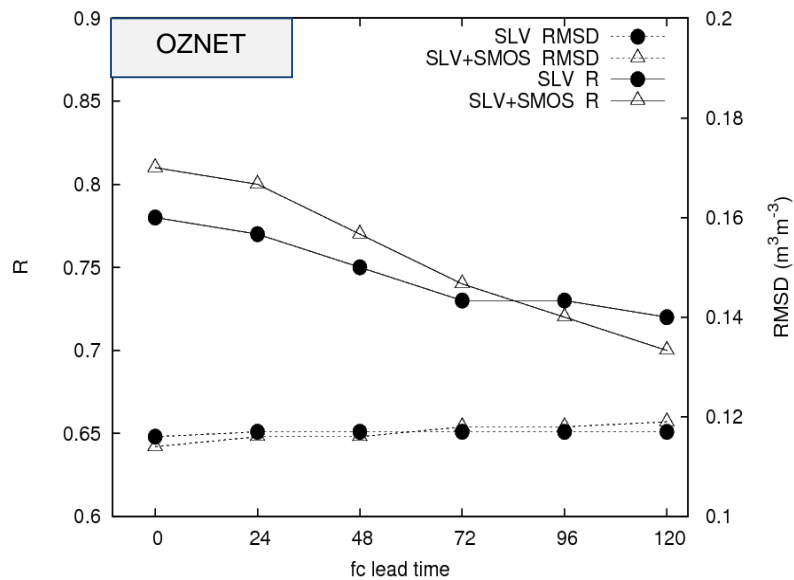

Primary objective achieved!

- ✓ Impact on soil moisture is high!,
- ✓ SM dynamic is improved and bias reduced,
- ✓ Root-zone is better characterised,
- ✓ Skill on the forecast of soil moisture improved at least up to 72 h.

Link soil moisture – weather/climate change

(c) $\Delta\Omega$ (temperature), GLACE

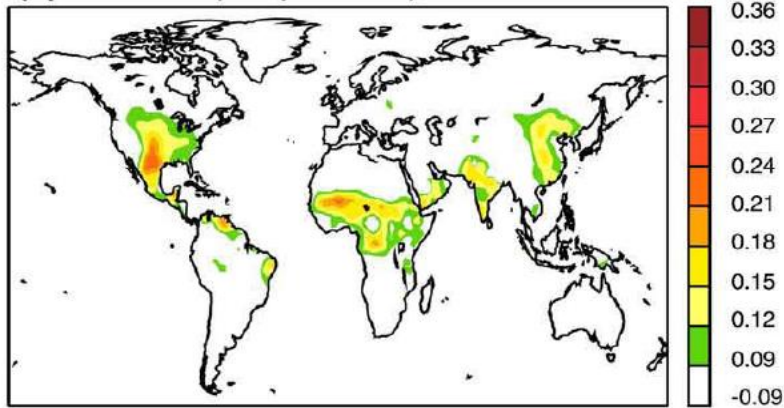

(d) $\Delta\Omega$ (precipitation), GLACE

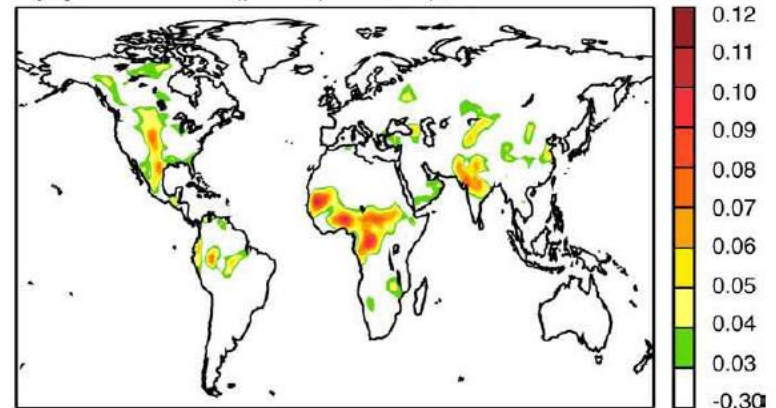

from Seneviratne et al., ESR (2010)

- Areas of strong coupling soil-atmosphere occurs in **transitional** regimes,
- Where SM strongly constrains ET variability and ET rates are large, thus resulting on strong feedbacks to the atmosphere

Link soil moisture – weather/climate change

(c) $\Delta\Omega$ (temperature), GLACE

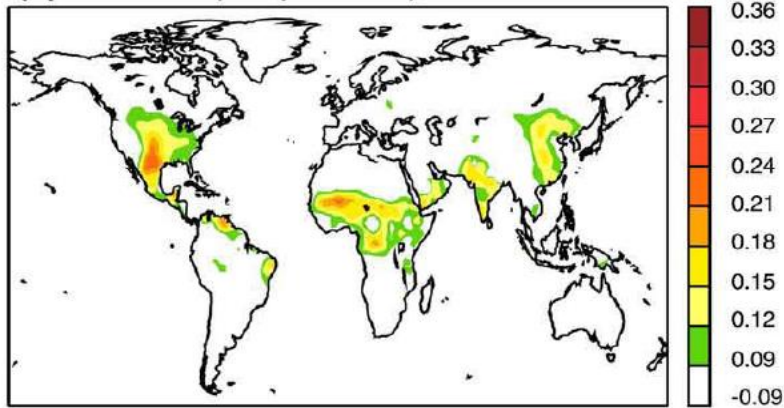

(d) $\Delta\Omega$ (precipitation), GLACE

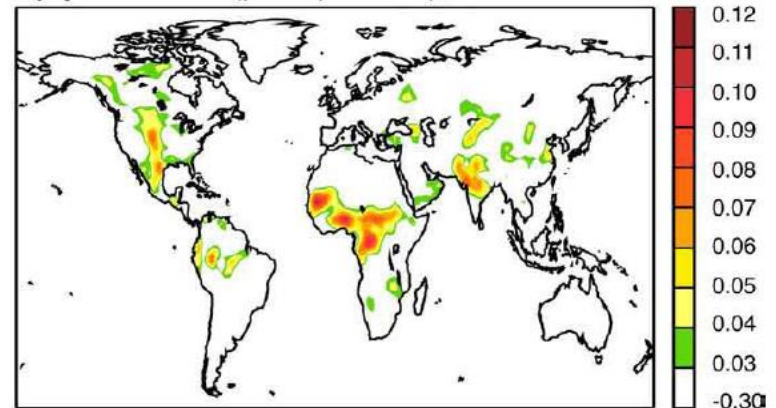

from Seneviratne et al., ESR (2010)

- Areas of strong coupling soil-atmosphere occurs in **transitional** regimes,
- Where SM strongly constrains ET variability and ET rates are large, thus resulting on strong feedbacks to the atmosphere

What do SMOS TBs “see”?

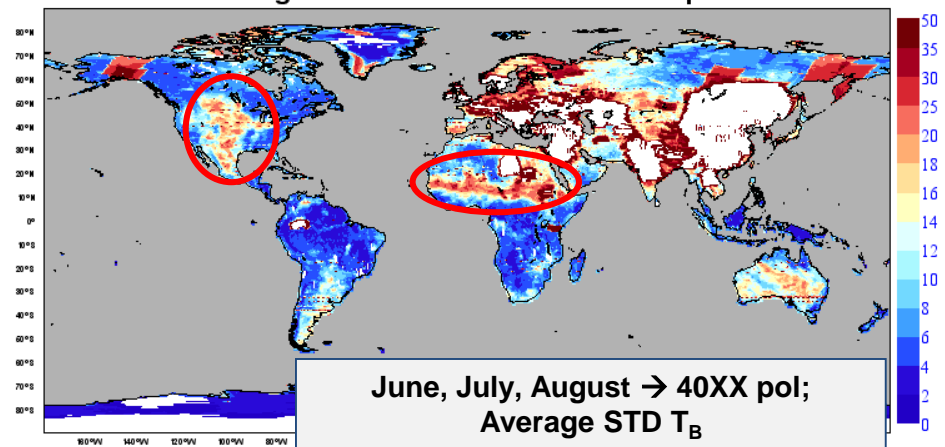

Impact on the forecast skill

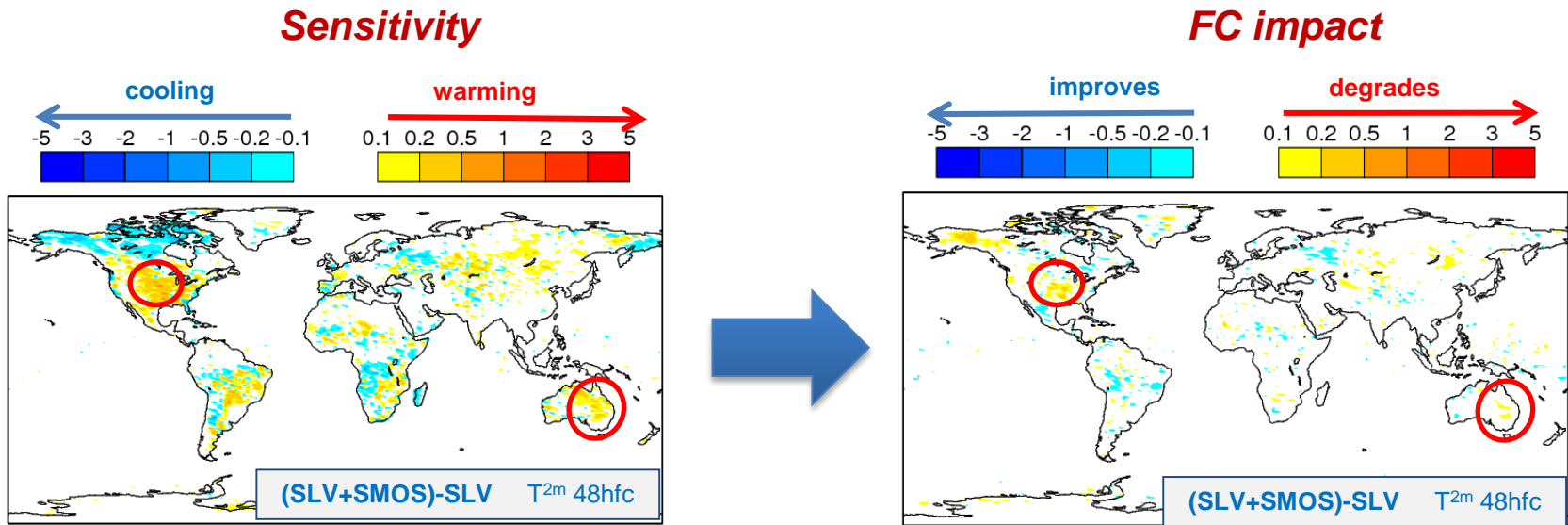

→ Large SMOS increments produce warmer and drier atmosphere in center US, Sahel, South of Africa and Australia → hot-spots for NWP impact,

→ Small impact in the skill of the forecast by assimilating SLV+SMOS.

SMOS DA impact experiments - Diagnostics

Assimil T^{2m}, RH^{2m} & SMOS T_B

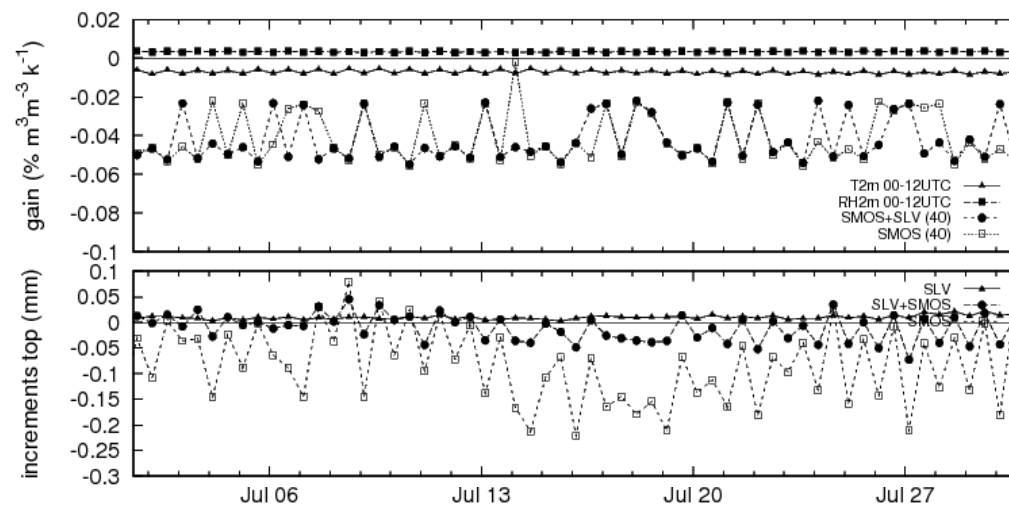
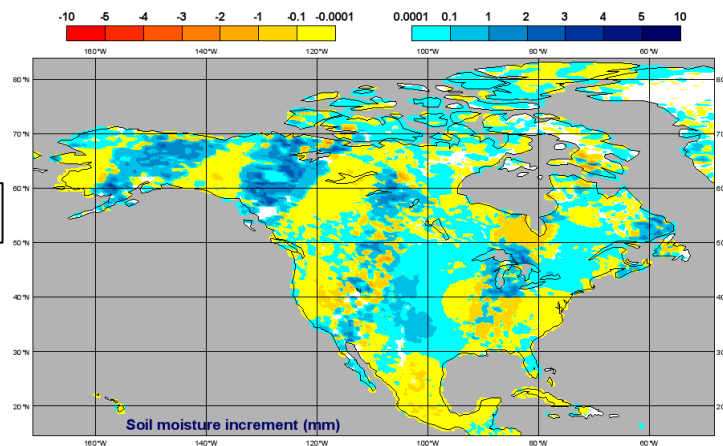

SMOS DA impact experiments - Diagnostics

Assimil T^{2m}, RH^{2m} & SMOS T_B

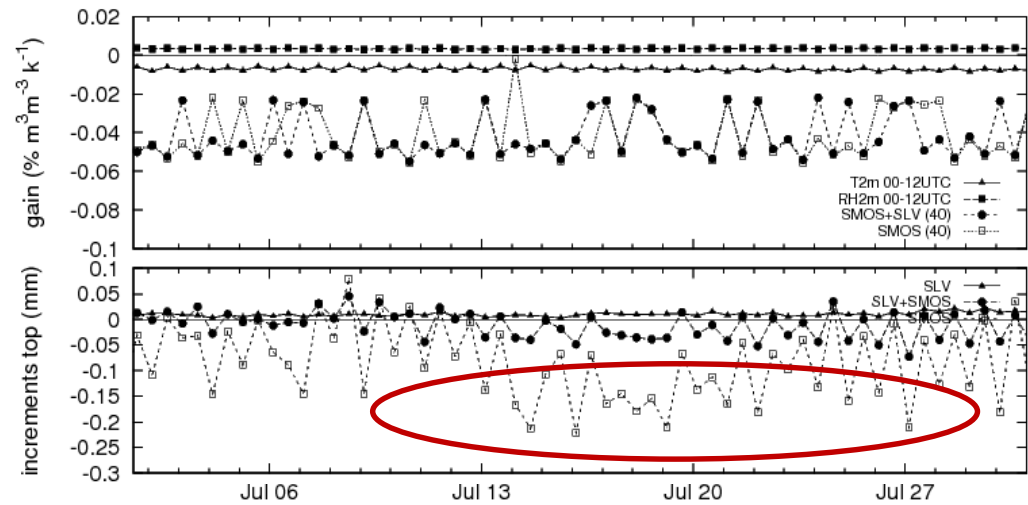
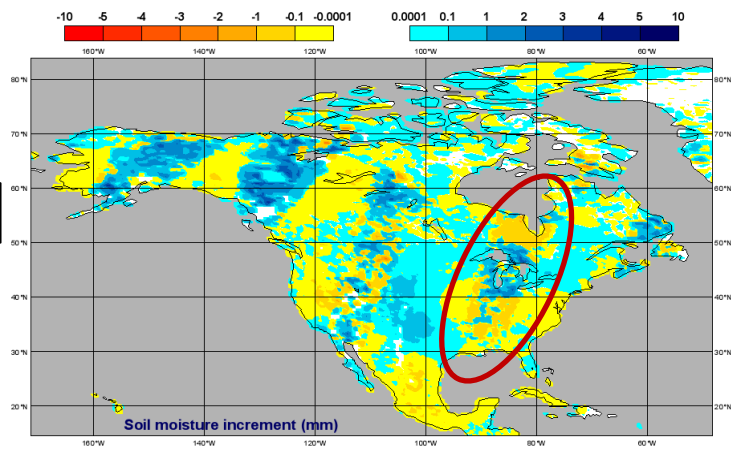

SMOS DA impact experiments

Assimil T^{2m}, RH^{2m} & SMOS T_B

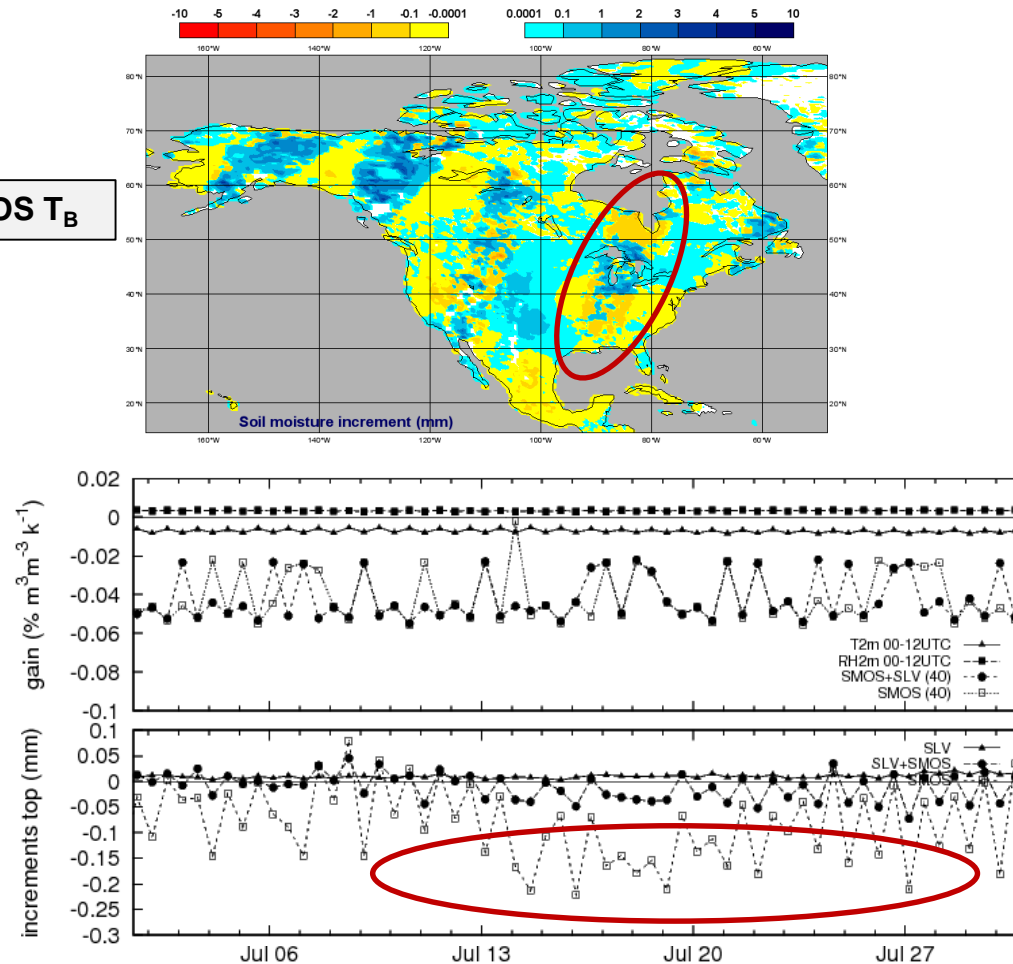

- The radiometric accuracy was used as best estimate of the SMOS observation error,
- The soil moisture background error is fixed to $0.01 \text{ m}^3 \text{m}^{-3}$ for all grid-points and layers

Sensitivity experiments

Investigate the effect of various types of assimilated observations, the assimilation approach and the observation (**R**) and background error (**B**) specification in the analysis of SM

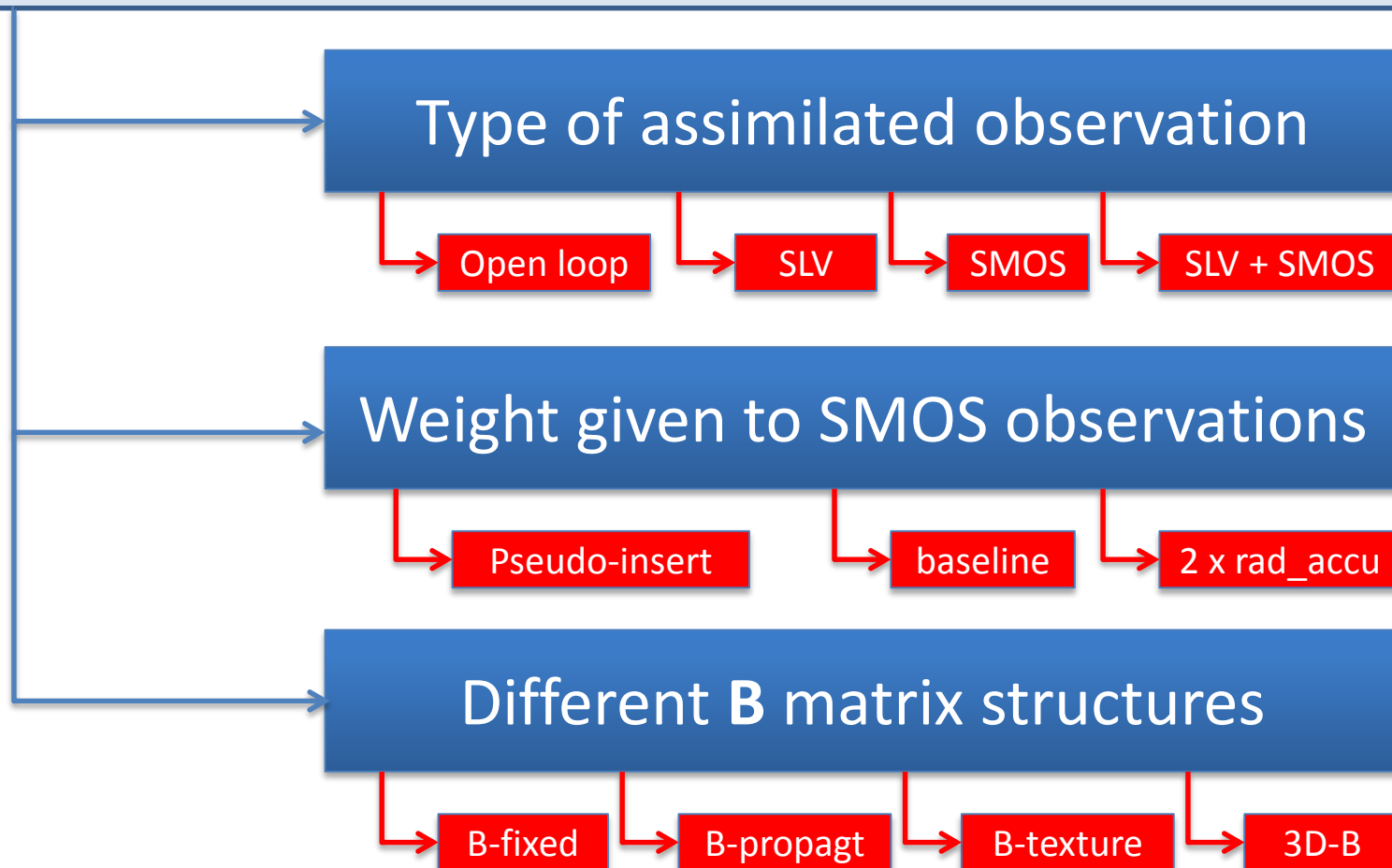

Atmospheric scores

Anomaly correlation of the forecast

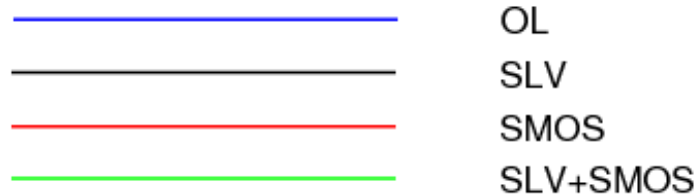

Temperature

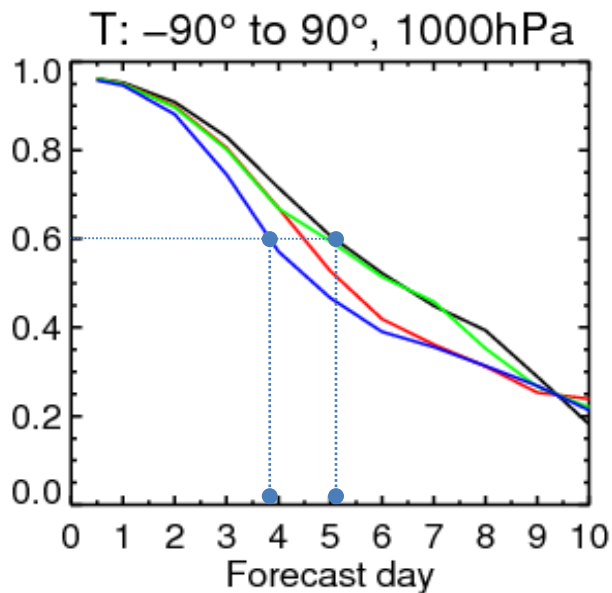

> 1 day

Humidity

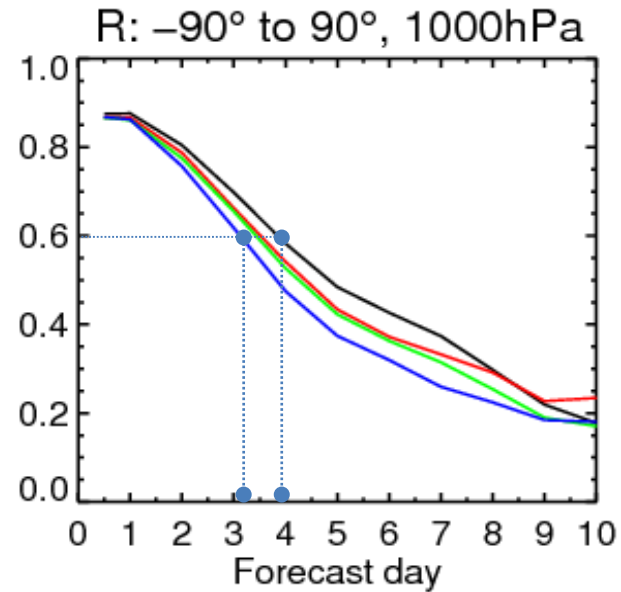

~ 1 day

Sensitivity experiments - Summer validation (JJA)

USCRN	Bias (m^3m^{-3})	RMSD (m^3m^{-3})	R	N
Direct Ins	-0.099	0.116	0.71	58
SMOS + R	-0.086	0.113	0.69	58
SMOS+2R	-0.096	0.117	0.74	58

SCAN	Bias (m^3m^{-3})	RMSD (m^3m^{-3})	R	N
Direct Ins	-0.051	0.106	0.68	83
SMOS + R	-0.032	0.101	0.69	83
SMOS+2R	-0.044	0.104	0.72	83

*Only stations with significant correlation values
Confidence 95% (p -value < 0.05)*

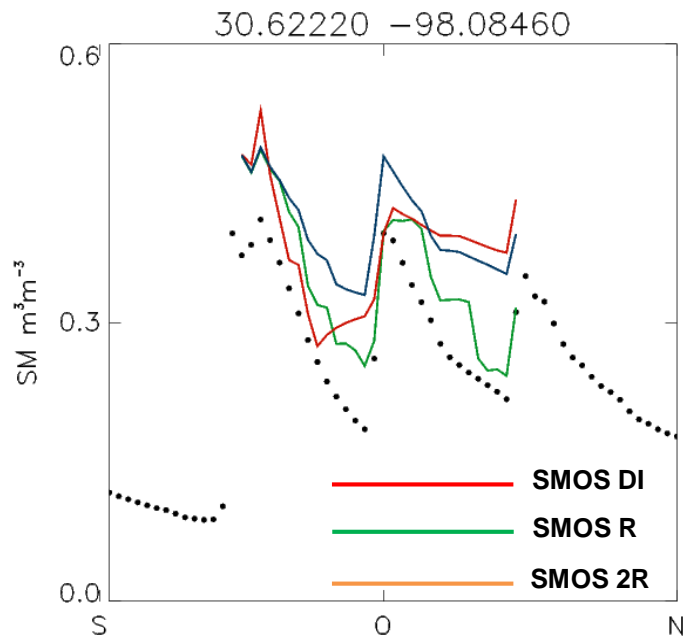

→ **Good impact of SMOS+2R in the root-zone (R)**

→ Doubling SMOS observation error and introducing soil texture information in the background error, in combination with SLV, could improve land and atmospheric scores in certain areas

Preparation for operational use

CTRL: T^{2m} , RH^{2m} , ASCAT SWI

Observation error (R):

- T^{2m} → $\sigma(T_{2M}) = 1$ K;
- RH^{2m} → $\sigma(RH_{2M}) = 4\%$;
- ASCAT SWI → $\sigma(SM_{ASCAT}) = 0.05$ m^3m^{-3}
- SMOS T_B → $\sigma(T_B) = 6 + p \cdot rad_acc$ K

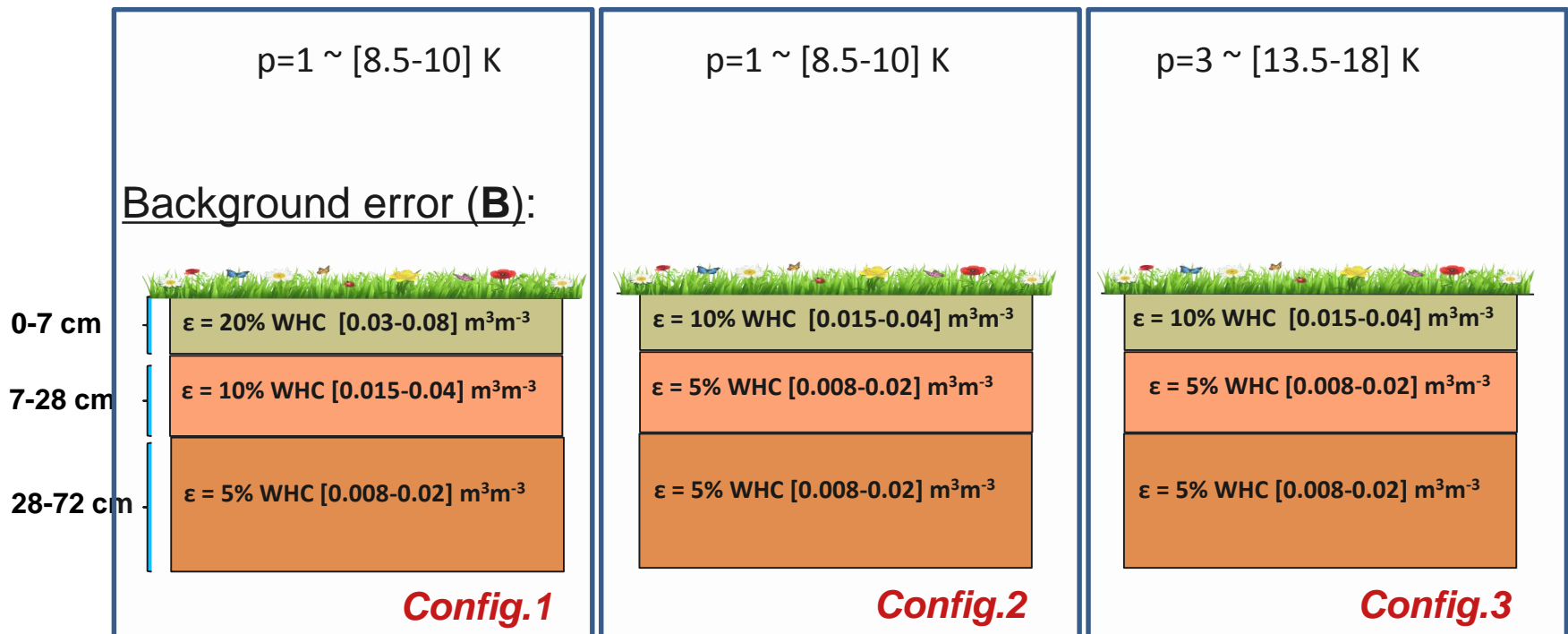

Atmospheric scores

Normalized change in rms of fc error: $\text{drmse} = \frac{\text{RMS}(e^{\text{SMOS}}) - \text{RMS}(e^{\text{CTRL}})}{\text{RMS}(e^{\text{CTRL}})}$; $e^{\text{EXPT}} = fc^{\text{EXPT}} - an^{\text{REF}}$
 $e^{\text{CTRL}} = fc^{\text{CTRL}} - an^{\text{REF}}$

drmse > 0 → expt increases error
 drmse < 0 → expt decreases error

— Config.1
 — Config.2
 — Config.3

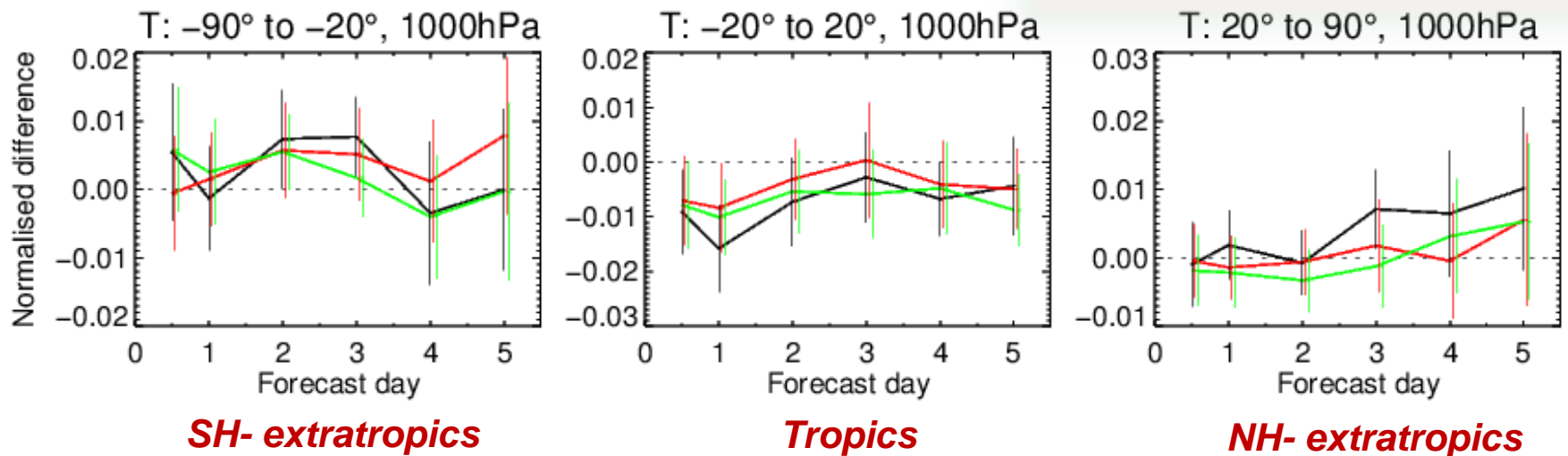

→ Neutral impact
 → For air humidity, some significant improvement, around 1% for config3

Atmospheric scores

Configuration

3

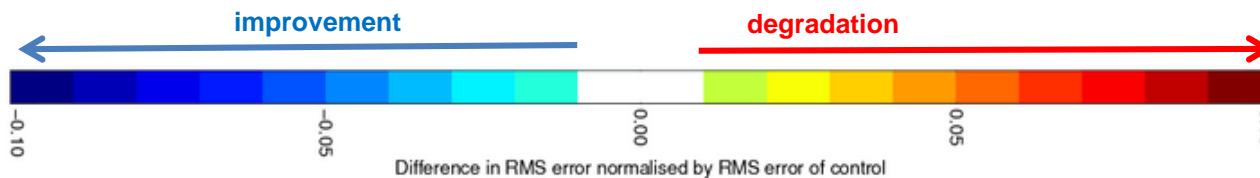
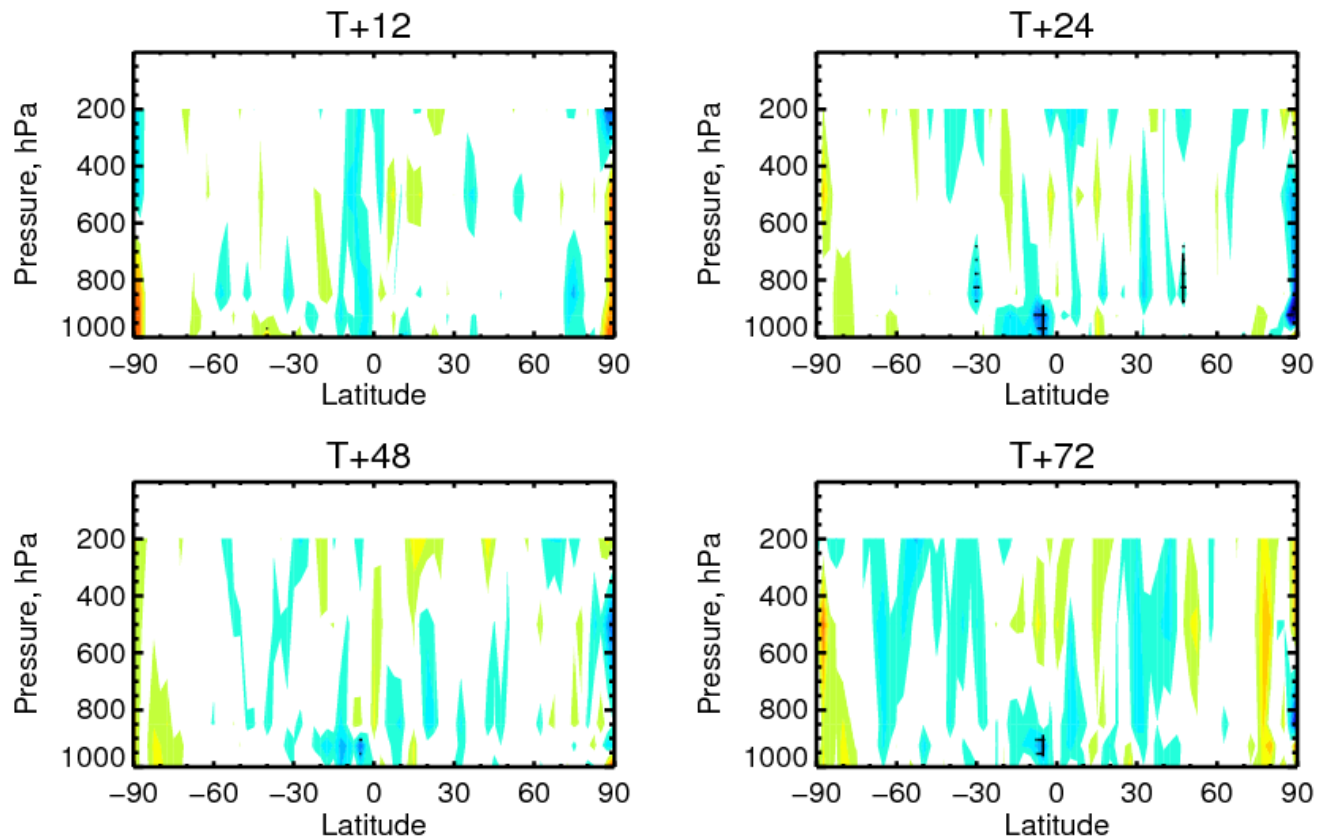

Conclusions and remarks

- SMOS data successfully integrated into the ECMWF coupled land-atmospheric forecasting system and land data assimilation scheme,

Conclusions and remarks

- SMOS data successfully integrated into the ECMWF coupled land-atmospheric forecasting system and land data assimilation scheme,
- Boreal summer expts:
 - Positive results in terms of shallow, root-zone soil moisture analysis and forecasts,
 - But limited atmospheric impact (with possible degradations)

Conclusions and remarks

- SMOS data successfully integrated into the ECMWF coupled land-atmospheric forecasting system and land data assimilation scheme,
- Boreal summer expts:
 - Positive results in terms of shallow, root-zone soil moisture analysis and forecasts,
 - But limited atmospheric impact (with possible degradations)
- Diagnostics and sensitivity experiments → The use of SMOS T_B in the ECMWF forecasting system should be optimised,
 - The integration of SMOS T_B in the ECMWF operational LDAS is plausible and it is a current extended objective,
 - Only SMOS “observable” very close to operational use, but...
 - Testing over long-term periods is needed,

Conclusions and remarks

- SMOS data successfully integrated into the ECMWF coupled land-atmospheric forecasting system and land data assimilation scheme,
- Boreal summer expts:
 - Positive results in terms of shallow, root-zone soil moisture analysis and forecasts,
 - But limited atmospheric impact (with possible degradations)
- Diagnostics and sensitivity experiments → The use of SMOS TB in the ECMWF forecasting system should be optimised,
 - The integration of SMOS T_B in the ECMWF operational LDAS is plausible and it is a current extended objective,
 - Only SMOS “observable” very close to operational use, but...
 - Testing over long-term periods is needed,
- Other components (bias correction, quality control) could be fine-tuned to optimise the use of SMOS in the assimilation system.
 - Influence in extended range forecasts?

Perspectives

- New soil moisture product in Near-Real-Time under implementation,
 - Collaboration ECMWF-CESBIO-ESA
 - Based on a Neural Network,
 - Very similar to the current operational but in Near Real Time,
 - With only 6 Tb, 6 indexes and soil temperature good quality product.

- To come up...
 - SMOS-hurricanes
 - Value of SMOS wind product under tropical storms/hurricane conditions.
 - Aligned with SMOS+storms evolution project,
 - Based on the hurricane wind speed database from SMOS+storms,
 - Focus primarily on case studies.

 - Currently defining new studies (sea-ice, extreme-winds, salinity,...)

Thanks for your attention !

contact: joaquin.munoz@ecmwf.int

Further information:

SMOS online monitoring in NRT:

<http://www.ecmwf.int/products/forecasts/d/charts/monitoring/satellite/smos/>

ECMWF SMOS website:

http://www.ecmwf.int/research/ESA_projects/SMOS/index.html

ECMWF CMEM website:

http://www.ecmwf.int/research/data_assimilation/land_surface/cmем/cmем_index.html

Sensitivity experiments

Investigate the effect of various types of assimilated observations, the assimilation approach and the observation (**R**) and background error (**B**) specification in the analysis of SM

- USA → best place for availability of observations and “cheaper” experiments,
- Period: 15 Sept- 14 Oct 2012 → recharge period, good variability of soil moisture,
- Full coupled land-atmospheric system,
- 3 angles (30, 40, 50), 2 polarisations (XX, YY), AF-FOV, RFI flag,
- Physics of cy40r1,
- Reduced observing system for the upper-air atmosphere; ATOVS, GBRAD and NEXRAD observations used to limit number of observations, and still reasonable atmospheric constrain.
- **R**: $\sigma(T^{2m}) = 2 \text{ K}$; $\sigma(RH^{2m}) = 10\%$; $\sigma(\text{SMOS}) \approx \text{rad_acc K}$
- **B**: $\sigma(\text{sm}_{(0-7) \text{ cm}}) = \sigma(\text{sm}_{(7-28) \text{ cm}}) = \sigma(\text{sm}_{(28-100) \text{ cm}}) = 0.01 \text{ m}^3\text{m}^{-3}$
- **Q**: $\sigma(\text{sm}) = 0.01 \text{ m}^3\text{m}^{-3}$

