



# Land Data Assimilation at ECCC

Marco L. Carrera, Bernard Bilodeau, Stéphane Bélair

*Meteorological Research Division, ECCC*

*24 August 2021, call with ECMWF*

# Mission and clients

---

*Provide initial conditions over continental surfaces for ECCC's numerical environmental prediction systems (NWP, hydrology, air quality) -- for soil moisture, terrestrial snow, surface temperature, and eventually for vegetation, lakes, cities*

*Provide land surface analyses to other government departments for their own operational products and services (Agriculture and Agri-Food Canada, Canadian Forests Service)*

*Basic principle is that the continental surface analyses should be as realistic as possible, i.e., based on accuracy assessment of the surface variables themselves, and not “calibrated” to optimize an application at the expense of the others*



# The Canadian Land Data Assimilation System

---

*Centered around an offline or external land-surface modelling capability. This allows for greater flexibility in terms of resolution at a much reduced computational cost.*

*1-D EnKF approach where the larger-scale assimilation is performed by means of a series of independent assimilation problems for each grid box. Horizontal error correlations between state variables from different grid boxes are neglected.*

*First-guess based upon SPS (Surface Prediction System) with ISBA or SVS (Soil, Vegetation and Snow) as the land-surface modeling component with an EnKF forecast step of 3 h.*

*Atmospheric forcing for the offline SPS are derived from short-range forecasts from the NWP trial fields. Stochastic perturbations are added to the atmospheric forcing variables to generate a spread among the ensemble members.*

*Precipitation perturbations are generated by combining a first-guess precipitation with observations using the CaPA methodology.*



# Observations in CaLDAS

---

*Traditional 2-m screen level observations of temperature and humidity. These observations are from the SYNOP and METAR networks. Used to “adjust” or nudge the soil moisture.*

*Satellite L-band observations of soil moisture from **SMOS** and **SMAP** for the analysis of soil moisture.*

*Land surface temperature (LST) retrievals from polar orbiters **AIRS** (Atmospheric Infrared Sounder/ **CRIS** (Cross-Track Infrared Sounder) / **IASI** (Infrared Atmospheric Sounding Interferometer) infrared sounders and geostationary GOES-R platforms (GOES-16).*

*In-situ snow depth observations for the optimum interpolation based snow analysis. More recently IMS snow-cover extent information.*

*Precipitation forcing for SPS is based on the assimilation of precipitation gauge observations using the CaPA methodology.*

*Observations are spatialized on the model grid a priori to application of the EnKF.*



# EnKF analysis in CaLDAS-sat versions

---

*EnKF with a forecast step of 3 h and consisting of 24 ensemble members.*

*SVS land-surface model as the land-surface modeling component.*

*Observations : SMOS and SMAP brightness temperatures, Land-surface temperature retrievals, in-situ snow depth observations, IMS snow cover extent, precipitation gauge observations.*

*Analyzed variables:*

*soil moisture(a depth of 40 cm)*

*surface temperatures for bare soil and vegetation*

*snow surface temperatures*

*snow depth*

*Forward model : Community Microwave Emission Modeling Platform (CMEM) developed at ECMWF.*

*Used to calculate a first-guess brightness temperature ( $T_b$ ) from SVS to compare with SMOS/SMAP.*



# Snow depth analysis in CaLDAS

---

- *Snow depth analysis in CaLDAS is not based upon an EnKF approach.*
- *The analysis is based upon an optimum interpolation (OI) analysis using in-situ snow depth observations.*
- *An OI snow depth analysis is performed for all 24 ensemble members and it is the average of the members which serves as the initial snow depth analysis from CaLDAS. A so-called ensemble OI approach.*
- *More recent development work has revised the OI approach for the snow analysis, replacing the in-situ snow depth observations with IMS snow cover extent data.*



# Operational status

---

**CaLDAS-screen HRDPS**: assimilation of screen-level parameters with EnKF for soil moisture and surface temperature, use of ensemble OI for continental snow, used as ICs for the High-Resolution (2.5 km, national) Deterministic Prediction System

**CaLDAS-sat NSRPS**: assimilation of SMAP+SMOS for soil moisture, assimilation of GOES for land surface temperature, ensemble OI for terrestrial snow, used as ICs for the High-Resolution (2.5 km, national) Deterministic Land Surface Prediction System (HRDLPS) which is used to feed the hydrological prediction models

**CaLDAS-sat GDPS**: assimilation of SMAP+SMOS for soil moisture, assimilation of AIRS, CrIS, IASI for land surface temperature, ensemble OI for snow, used as ICs for the Global Deterministic Prediction System (15 km) -- **this system was intended for current implementation cycle, but had to be pulled and is now on hiatus.**









# CaLDAS-sat for NSRPS (surface and river prediction system)

*Example of the impact of the assimilation of SMAP+SMOS in CaLDAS on hydrologic analysis system*

*Nelson River shown here*

*Two experiments forced by CaLDAS-sat and ensemble precipitation analyses*

*Period of 20190701 to 20191031*

*Analysis mode, but no assimilation of river flows (to better isolate the effect of SMAP and SMOS)*

**Blue:** DHPS (hydro) forced with CaLDAS control member (no assimilation)

**Red:** DHPS (hydro) forced with median of CaLDAS analyses (w/ **SMAP** + SMOS)

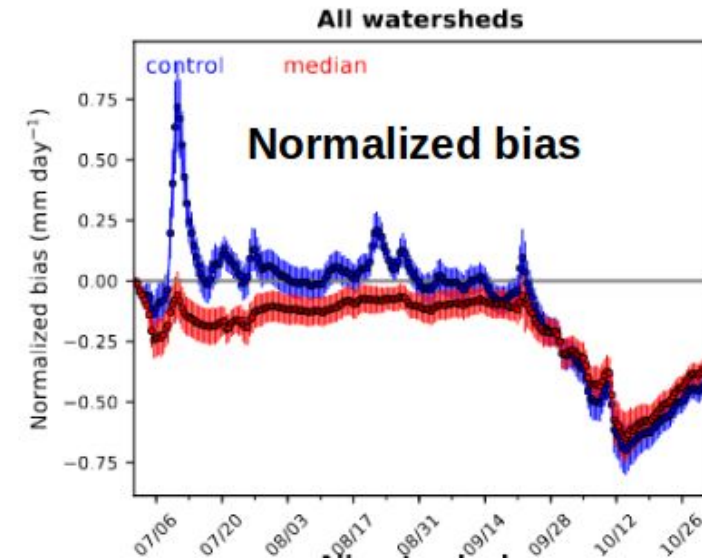
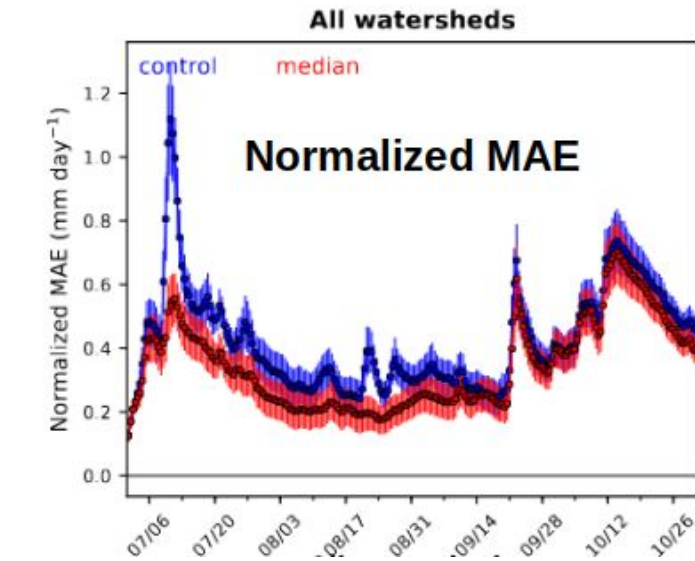

# CaLDAS-screen for HRDPS (regional det. short-range NWP)

“screen” version of CaLDAS implemented in 2015 in deterministic 2.5-km NWP system over Canada. In this version, screen-level observations are assimilated using an EnKF approach, and snow is based on ensemble OI (Milbrandt et al. 2016)

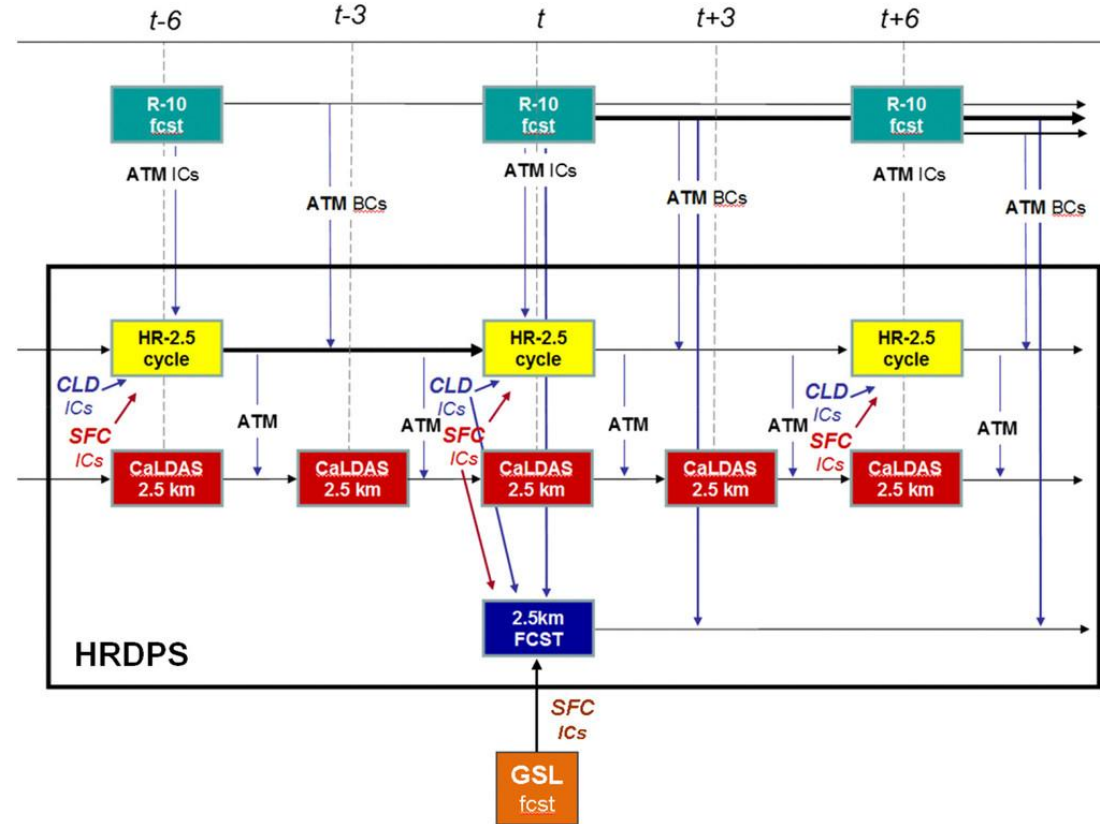
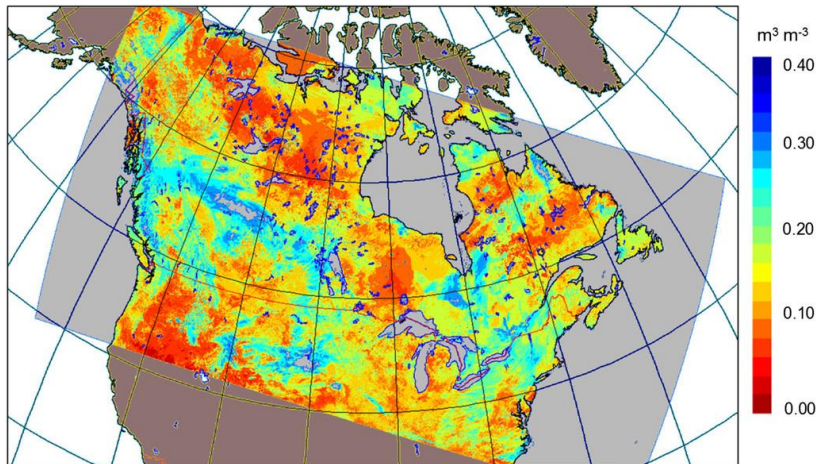

Figures from Milbrandt et al. (2016)



# CaLDAS-sat for GDPS (global det. medium-range NWP)

*CaLDAS with SMAP, SMOS, AIRS, CrIS, IASI, together with land surface scheme SVS, new surface fields, and several other changes to the atmospheric model GEM to accommodate the new land surface package.*

*Impact is substantially positive at the surface, using objective evaluation vs surface observations and vs screen-analyses*

Summer 2019, screen-level, humidity (dew point), Canada

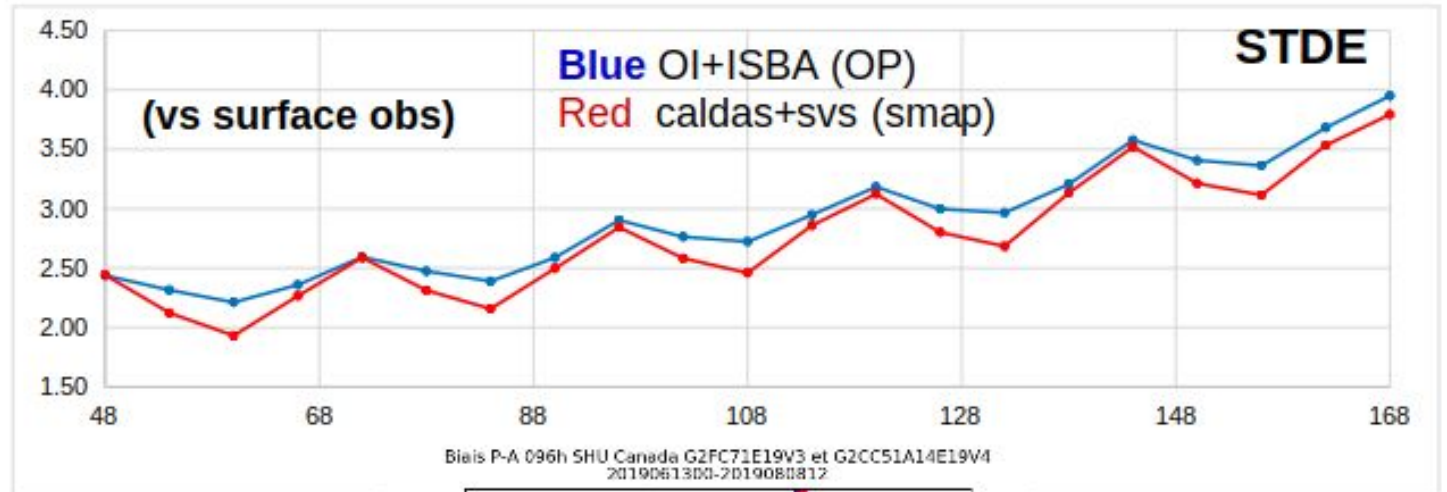

All 00 UTC runs

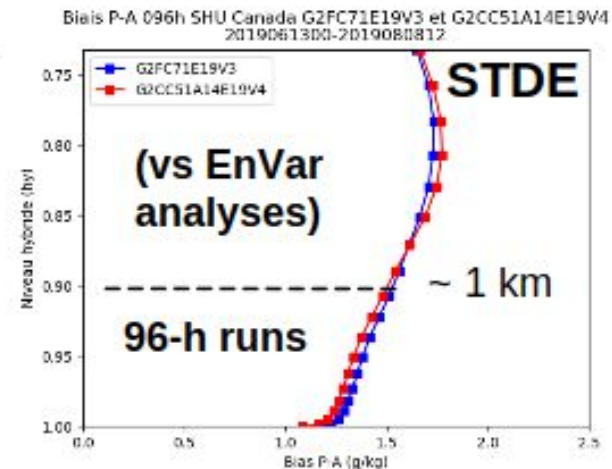



# CaLDAS-sat for GDPS (global det. medium-range NWP)

... but the proposal had to be pulled from the current implementation cycle due to what was argued as being a deterioration for upper-air forecasts (in particular for air temperature at 850 hPa).

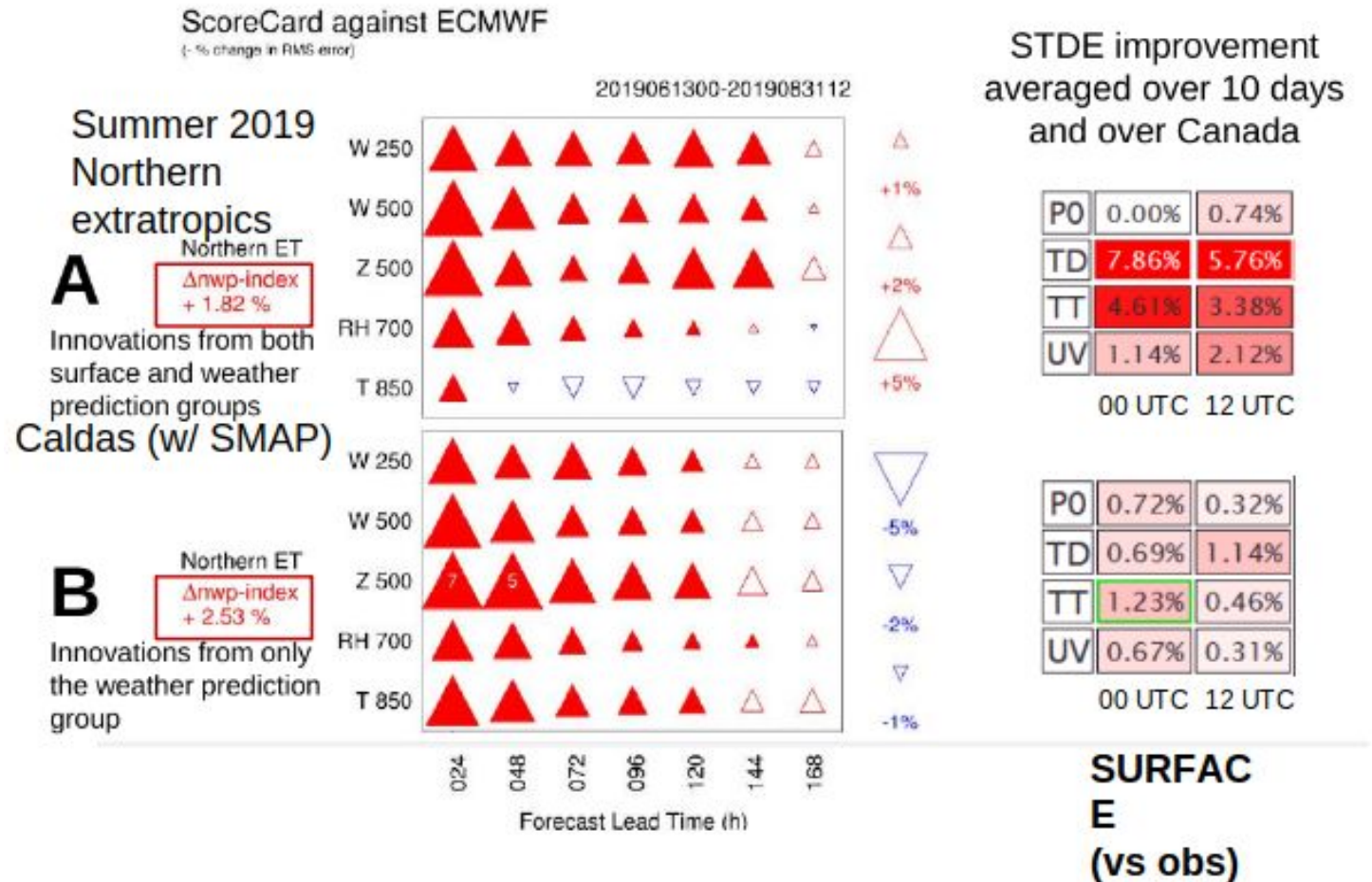

# Right now... a period of transition

---

*Finalize implementation of CaLDAS-sat in NSRPS*

*CaLDAS-sat GDPS is in limbo (disagreement on the NWP impact of what is proposed, current / traditional evaluation and decision process does not work)*

*Field-scale soil moisture (100m) based on high-resolution modeling with SVS and on assimilation of soil moisture products obtained from ANN process of Radarsat Constellation Mission (RCM) data (eventually Sentinel-1 also)*

*Papers on the way: impact of SMAP/SMOS on global NWP, evaluation of NWP forecasts using screen-level analyses, quality of the screen-level analyses with CaLDAS-sat, statistical links between errors at the surface and in the PBL.*



# Next steps... difficult to decide what to prioritize...

---

**Observational inputs:** ASCAT, Sentinel-1, RCM, NISAR, MSG, Himawari, more surface stations for snow

**Methods:** 3D EnKF, hybrid ensemble - variational, neural networks, FSOI, IAU

**Coupling with atmospheric DA:** direct approach of including land surface variables as control variables in atmospheric 4d-EnVar, or keeping the two systems separate with a more consistent connection, or hybrid approach -- e.g., surface temperature from atmospheric DA, the rest with land surface DA; coupling with ensemble DA

**Expend CaLDAS** to include assimilation of vegetation characteristics, temperature over urban areas

**Reanalysis** 2009-current date with CaLDAS-sat

Improve **screen-level analyses**; use for forecast evaluation (ongoing)

**Other aspects:** precipitation analysis with CaPA, first-guess modeling with SVS-TEB